

JTS® PROFESSIONAL CO., LTD

www.jts.com.tw



59508-085-01

JTS[®]

JTS PROFESSIONAL CO., LTD.

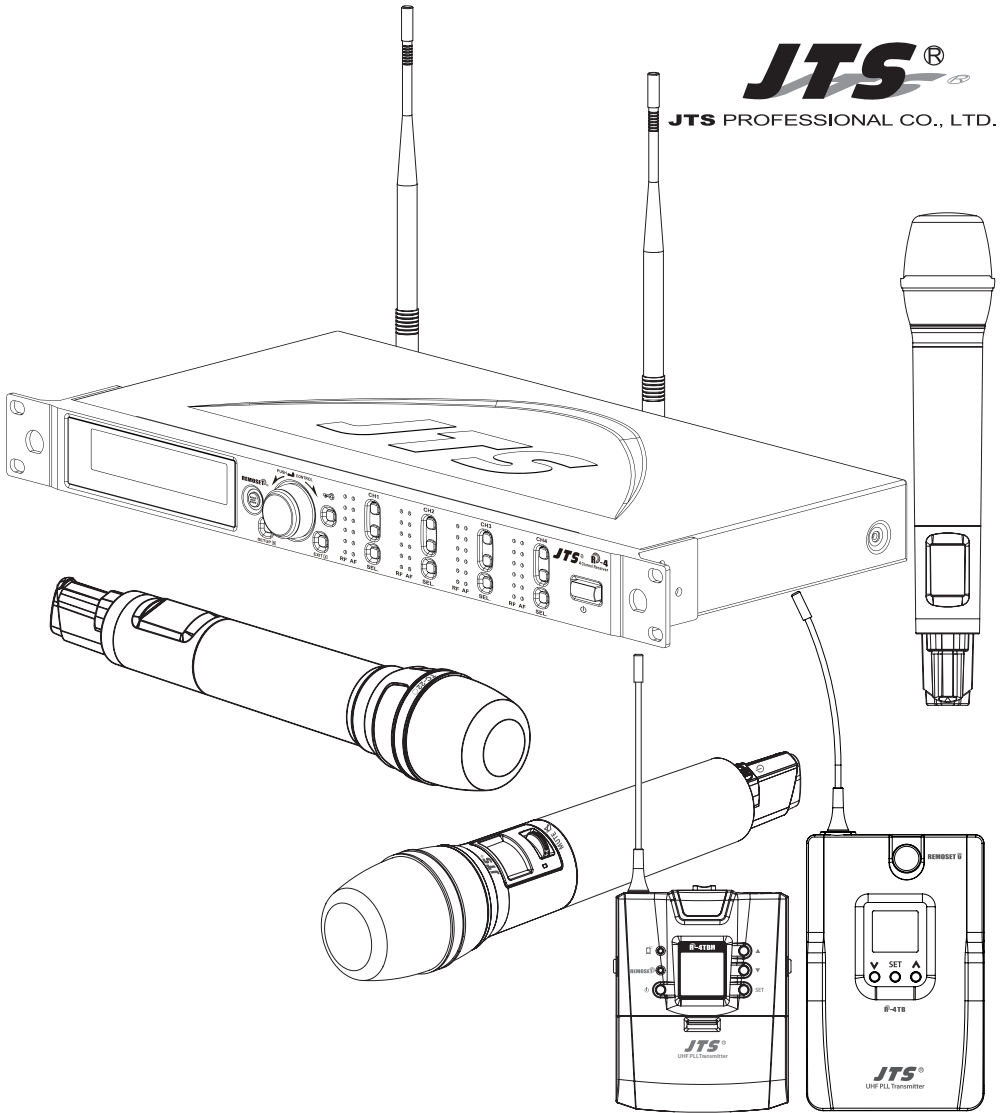

UHF PLL Instruction Manual

R-4 / R-2

R-4TH / R-4THA / JSS-4A / JSS-4B

R-4TB / R-4TBM



With JTS **REMOSET**[®] 2.4G RF Synchronizing Technology

One-Year Warranty Card

Product model		Serial number	
Customer		Phone number	
Address			
Date of purchase			
Distributor' s shop seal	The distributor' s shop seal and date of purchase are required for the warranty to be valid!		

Warranty Service

1. The warranty card must be presented with the date of purchase and attached at the bottom of the machine to ensure the validity of warranty service.
2. The warranty is valid for one year starting from the date of purchase shown on "warranty label" attached to the product; alternatively, the warranty is valid for 15 months starting from the date the product was manufactured if the "warranty label" is missing on the machine. If the microphone is returned for service but with the machine, the warranty is valid for 15 months starting from the date of manufacturing shown on the microphone.
3. If malfunction occurs under normal operations according to the instruction manual while the warranty is still valid, please call the shop where you purchased the product for warranty service.
4. It is important to return both the machine and microphone back to the shop for service, since this makes it easier to identify where the possible problem is and determine whether a service fee is needed.
5. JTS will provide service free of charge while the warranty is still valid. However, A fee for parts and/or service may be charged for the following:
 - a. Damage due to natural disaster or any other irresistible factors;
 - b. Damage due to dropping, immersion in water, exposure to high humidity, corrosion, ingress of alien objects, or loss of parts;
 - c. Consumables are not part of the warranty; or
 - d. The "warranty label" is not found on the machine or the "warranty label" is damaged to the point that the validity of warranty is not recognizable.
6. Keep this warranty card at a safe place, as the warranty is invalid with a lost warranty card.

Contents

1. Notes for system operations	1
2. Features	1
3. Specifications	2
3-1 UHF PLL 4-channel / 2-channel, diversity receiver	2
3-2 UHF PLL handheld transmitter	3
3-3 UHF PLL body-pack transmitter	5
3-4 Optional Condenser Microphon	7
4. Parts	9
4-1 UHF PLL 4-channel / 2-channel, diversity receiver // R-4 / R-2	9
4-2 UHF PLL handheld transmitter // R-4TH / R-4THA	13
4-3 UHF PLL handheld transmitter // JSS-4A / JSS-4B	15
4-4 UHF PLL body-pack transmitter // R-4TB	17
4-5 UHF PLL body-pack transmitter // R-4TBM	19
4-6 Accessories	21
4-7 Microphone Choices	21
5. Connection	24
5-1 Connecting transmitter	24
5-2 Installing transmitter // R-4TH / R-4THA	26
5-3 Installing transmitter // JSS-4A / JSS-4B	27
5-4 Installing transmitter // R-4TB	27
5-5 Installing transmitter // R-4TBM	28
6. Operation	29
6-1 Operation // R-4 / R-2	29
6-2 Operation // R-4TH / R-4THA	37
6-3 Operation // JSS-4A / JSS-4B	40
6-4 Operation // R-4TB	46
6-5 Operation // R-4TBM	49
7. Digital Code Alert Function	55
8. Notes for the product	56

1. Notes for system operations



- Before connecting to the main power supply, check that the power requirements shown on the nameplate of the machine meet the output of the adaptor.
- Do not place the machine at a place where high temperature and humidity are expected.
- Do not operate the system with wet hands.
- Keep the machine away from any heat or ignition source.
- Before setting up the machine, make sure that the volume is set at the minimum for both the mixer and amplifier.

2. Features

- The system features the latest anti-interference digital code circuit design that is proven to isolate the interference between the system and the outside world.
- Up to 36MHz of bandwidth with a maximum of 1440 channels to choose from
- Adjustable squelch level
- Default with 6 groups, up to 22 available
- User-defined groups provided
- Automatic scan
- Provided with antenna booster power
- JTS patent: the latest RF **REMOSET**® allows the transmission of not only frequency, but also data such as sensitivity, low cut, transmission power and key lock to the transmitter.
- With one push of the **REMOSET**® key, upto four transmitters can be synchronized.
- RF "no signal" alert on LCD display
- AF "microphone mute" alert on LCD display
- Transmitter "low battery" alert on LCD display
- Antenna and power cascading for improved performance and convenience.
- Digicode prevents intermodulation

3. Specifications

3-1 UHF PLL 4-channel / 2-channel, diversity receiver

Model		
Frequency oscillation	Phase-locked loop, PLL	
Carrier frequency	470~960 MHz	
No. of channels	4 channels	2 channels
Channel pairing	RF REMOSE [®]	
Diversity	antenna diversity	
Bandwidth	36MHz	
Signal/noise ratio	>106dB(A)	
Total harmonic distortion	<0.5%@1KHz	
Receiving sensitivity	-95dBm · S/N>80dB	
Mirror rejection ratio	>80 dB	
General frequency response	50Hz~18KHz±2dB	
Antenna connector	BNC female	
Antenna booster power	DC12V/100mA	
Display	LCD	
Functions displayed	Group, channels, frequency, transmitter power, antenna A/B, mute, AF, RF, channel scan, output level, volume, Device ID	
Controls	Power ON/OFF, groups, channels, frequency, receiving sensitivity, key lock, volume, output attenuation (XLR), channel scan (ON/OFF), antenna power, display setting	
Audio output level	Ref : ±22.5KHz Dev@1KHz Tone	
	ψ6.3 Phone Jack : -10dBV	
	XLR Jack : -4dBV(Line) ~ -24dBV(MIC)	
Audio output impedance	600Ω	
Mute	Noise mute and Pilot Tone	
Output port	5 balance XLR ports, 1 unbalance φ6.3mm jack	3 balance XLR ports, 1 unbalance φ6.3mm jack
Power	100~240VAC	
Dimensions	485mm L x 230mm W x 44mm H	
Remark	Specifications provided above may be slightly different from the product without further notice.	

3-2 UHF PLL handheld transmitter

Model	R-4TH / R-4THQ
Frequency oscillation	Phase-locked loop, PLL
Carrier frequency	470~960MHz
Bandwidth	108MHz as per local regulation
Pairing	RF Remoset
RF power output	10mW/50mW (as per local regulation)
RF stability	$<\pm 10\text{KHz}@F_c$
Modulation frequency deviation	$\pm 48\text{KHz}$
Spurious Emissions	$<-50\text{dBc}$
LCD display	Group, channels, frequency, mute, auto off, input level attenuation, sensitivity adjustment, power indication, Device ID
Controls	Power, mute, groups, channels, frequency, sensitivity adjustment, input level attenuation, auto off, transmission power, key lock
Battery	AA Alkaline battery x 2
Charging	Yes
Dimension	265mm L x 51.2mm W x 51.2mm H
Remark	Specifications provided above may be slightly different from the product without further notice.

Model	JSS-4Q / JSS-4B
Frequency oscillation	Phase-locked loop, PLL
Carrier frequency	UHF 470~960 MHz
Bandwidth	108 MHz as per local regulation
Pairing	RF Remoset
RF power output	10mW / 50mW (as per local regulation)
RF output	Hi / Lo adjustable
Stability	$<0.005\%$
Frequency deviation	$\pm 48\text{kHz}$
LCD display	Group and channel, frequency, power indication, transmission power, sensitivity, Device ID, username, gain, low cut
Controls	Power ON/OFF, frequency setting, group, sensitivity, bass attenuation, pairing ID, frequency pairing, transmission power adjustment, display contrast, backlight time setting, Chinese/English selection, key lock pattern, mute, reset
Harmonic radiation	$<-50\text{ dBc}$

Audio frequency response	50KHz~18KHz
Capsule Module	Interchangeable
Battery	AA Alkaline battery x 2 / rechargeable battery x 2
Charger	CH-2,CH-8
Dimensions	35.5mm L x 50mm W x 253mm H
Remark	Specifications provided above may be slightly different from the product without further notice.

3-3 UHF PLL body-pack transmitter

Model	P-4TB
Frequency oscillation	Phase-locked loop, PLL
Carrier frequency	470~960MHz
Bandwidth	108MHz as per local regulation
Paring	RF Remoset
RF power output	10mW/50mW(as per local regulation)
RF stability	<±10KHz
Modulation frequency deviation	±48KHz(Peak)
Spurious Emissions	<-50dBc
LCD display	Group, channels, frequency, mute, auto off, input level attenuation, sensitivity adjustment, power indication, Device ID
Controls	Power, mute, groups, channels, frequency, sensitivity adjustment, input level attenuation, auto off, transmission power, key lock
Input connector	4-pin mini XLR
Controls	Power, mute, group, channel, frequency, sensitivity adjustment, input level attenuation, auto off
Battery	AA Alkaline battery x 2
Charger	CH-2 CH-8
Dimension	62.3mm L x 20mm W x 97mm H
Remark	Specifications provided above may be slightly different from the product without further notice.

Model	R-4TBM
Frequency oscillation	PLL Synthesized Control
Carrier frequency	UHF 470~960 MHz
Bandwidth	108MHz as per local regulation
Rf power outputs	Low / High
RF stability	$\leq \pm 10\text{KHz}$
Modulation frequency deviation	$\pm 48\text{KHz}$ (Peak)
Chassis	Aluminium alloy
Lcd display	Group, Channel, Frequency, Battery Status, GAIN Adjust
Controls	Power ON/OFF, AF Level, Frequency (Up/Down), Lock-on Mode, REMOSET ID, RF Output Adjust
Input connector	4P Mini XLR
Spurious emissions	$< -50\text{ dBC}$
Audio frequency response	50Hz~18k Hz
Battery	AA NiMH x2
Dimension	62mm W x 80.3mm H x 22.6mm D
Weight	93g

3-4 Optional Condenser microphone

Lavaliere microphone

Model	CM-501	CM-201i	CM-125i
Output connector	4-pin mini XLR		
Frequency response	100~15,000 Hz	60~15,000 Hz	50~18,000 Hz
Directionality	Cardioid directionality	Omni-directionality	
Sensitivity	-60 ± 3dB	-60 ± 3dB	-53 ± 3dB
Output impedance	2.2K Ω		4.4K Ω
Max. sound pressure allowed	130dB		
Dimension (mm)	∅10.1mm W x 26.4mm H	∅5mm W x 9mm H	∅4mm W x 11mm H
Weight	21.5g	20.7g	7g (cable not included)

Headset microphone

Model	CM-214i	CM-214Ui	CM-214ULi
Output connector	4-pin mini XLR		4P/3P mini XLR/3.5stereo jack
Output connector (optional)	3P Mini XLR/3.5 stereo plug/4P Hirose jack		4P Hirose jack
Frequency response	60~15,000 Hz	30~18,000 Hz	100~18,000 Hz
Directionality	Omni-directionality	Cardioid directionality	
Sensitivity	-60 ± 3dB	-68 ± 3dB	-75 ± 3dB
Output impedance	1.8kΩ	680Ω	1.8kΩ
Max. sound pressure allowed	130dB		120dB
Dimension (mm)	157mm L x 125mm W x 134mm H	157mm L x 205mm W x 134mm H	157mm L x 125mm W x 134mm H
Weight	32.9g	38.4g	18g (cable not included)

Model	CM-235i	CX-504
Output connector	4P-pin mini XLR	
Output connector (optional)	3P Mini XLR/3.5 stereo plug/4P Hirose jack	
Frequency response	50~18,000 Hz	30~18,000 Hz
Directionality	Omni-directionality	Cardioid directionality
Sensitivity	-53 ± 3dB	-68 ± 3dB
Output impedance	1.8kΩ	680Ω
Max. sound pressure allowed	130dB	
Dimensions (mm)	157mm L x 155mmWx 134mmW	111.3mm L x 285mmWx 55mmW
Weight	17g	56.3g

Ear-hook microphone

Model	CM-801 / CM-804i	CM-8015 / CM-825i
Output connector	4-pin mini XLR	
Output connector (optional)	3P Mini XLR/3.5 stereo plug/4P Hirose jack	
Frequency response	60~15,000 Hz	50~18,000 Hz
Directionality	Omni-directionality	
Sensitivity	-64 ± 3dB	-53 ± 3dB
Output impedance	1.8KΩ	
Max. sound pressure allowed	130dB	

4. Parts

4-1 UHF PLL 4-channel diversity receiver // **R-4**
 UHF PLL 2-channel diversity receiver // **R-2**

R-4 Front panel

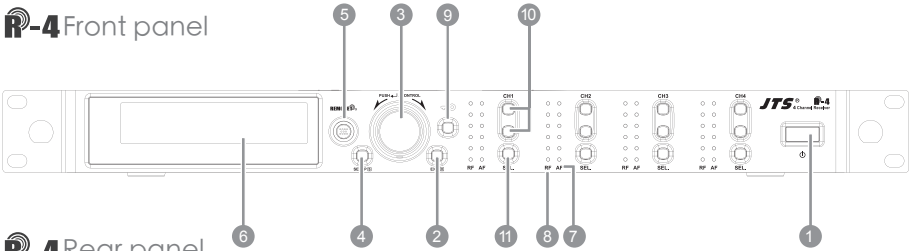

R-4 Rear panel

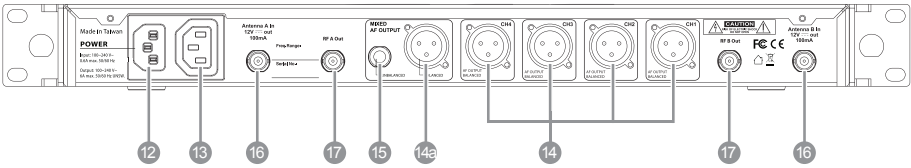

R-2 Front panel

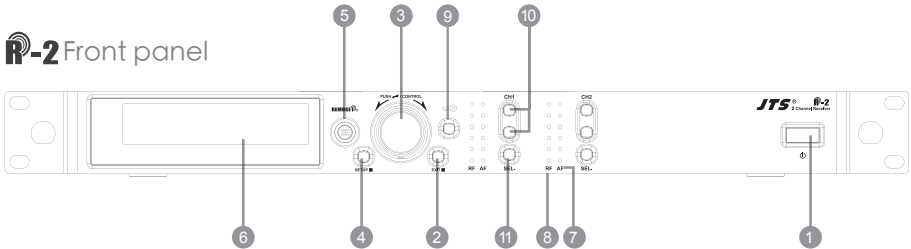

- 1 **Power ON/OFF** : ON : push once to turn on
 OFF : push and hold until "Power OFF" is shown on the LCD to turn off.
- 2 **EXIT** : Push exit to cancel a selection or exit from the current menu when R-4/2 is in the "setting menu."
- 3 **Rotary Switch** : when in the "function menu," turn the switch to select the desired function; push the switch (or SETUP) to enter the selection and spin the switch to select the setting. Push [SETUP] to save the setting.
- 4 **SETUP** : Push and hold for 2 seconds to enter the vsetting menu." Push SETUP to save the setting once the selection and setting are made according to "3. Rotary Switch."

- 5 **REMOSET** : When the receiver setting is done, push **REMOSET**  to transmit the setting data to the handheld or body-pack transmitter.
- 6 **LCD display** : See "Receiver LCD display instructions."
- 7 **AF**: indicates the current strength of audio frequency signals.
- 8 **RF**: indicates the current strength of radio frequency signals.
- 9 **Key lock**: push and hold for 2 seconds to lock all keys, and again to unlock.
- 10 **Volume keys** : push ▲/▼ keys to adjust the volume between 0 and -31 dB.
- 11 **Selection key** : push this button
- Push SETUP to enter the setting for the selected channel for parameter settings.
 - Push REMOSET to transmit the setting data to the transmitter in this selected channel.
- 12 **AC Power Jack** : connects 100-240VAC power.
- 13 **AC power cascading** : use AC double power cable (optional) for power cascading.
- 14 **XLR audio jack** : balanced audio signal output
- 14a **XLR audio jack** : balanced audio signal output after mixing
- 15 **Ø6.3 audio output jack** : unbalanced audio signal output after mixing
- 16 **Antenna A (B) input terminal** : BNC antenna input jack that also provides DC12V/100mA output.
- 17 **RF signal A (B) output terminal** : RF signal output jack; it is possible to connect the RF A (or B) OUT of the first unit to the antenna A (or B) IN of the second unit with a BNC-BNC signal cable, and then the RF A (or B) OUT of the second unit to the antenna A (or B) IN of the third unit, and so on and so forth. The cascade may consist of up to 10 units to minimize the number of antennas used.

Note: Each cascading may bring 1.2dB attenuation to RF signal.

R-4 LCD displays

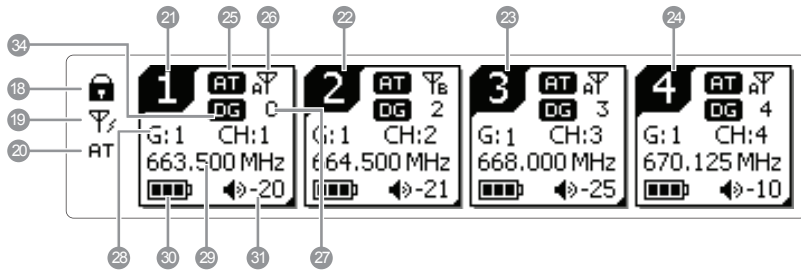

R-4 Setting page

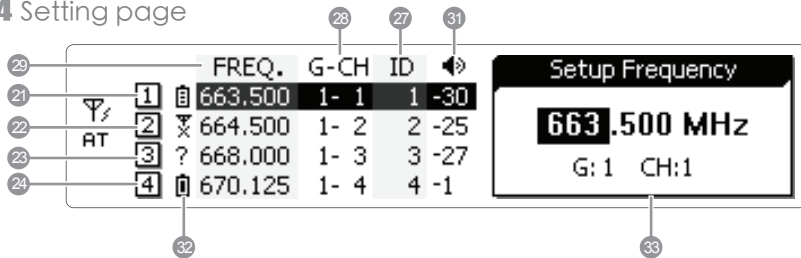

18 Key lock

19 Antenna power supply ON

20 Mixed output attenuation ON

21 Receiver channel 1

22 Receiver channel 2

23 Receiver channel 3

24 Receiver channel 4

25 Output attenuation ON

26 Antenna selection A/B

27 Device ID

28 Group/channel

29 Frequency

30 Transmitter battery

3blocks: R-4TH/R-4THA/R-4TB
microphone is used



5blocks: JSS-4A microphone is used

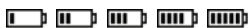

[?]: waiting for battery
information from transmitter

31 Volume

32 Transmitter battery

3blocks: R-4TH/R-4THA/R-4TB
microphone is used



5blocks: JSS-4A microphone is used



? : waiting for battery information
from transmitter







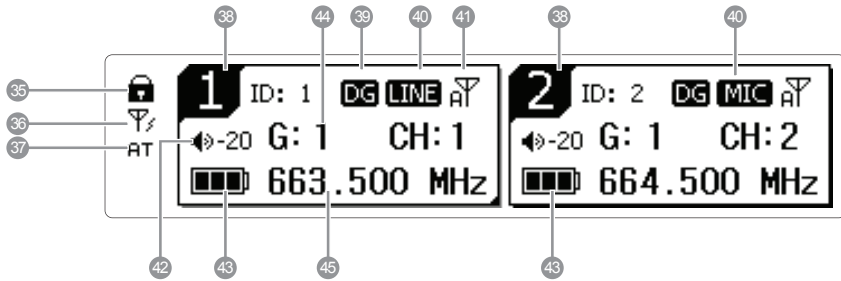

X : no microphone signal

33 Setting window

34 Digital code ON

P-2 LCD displays



- 35 Key lock
- 36 Antenna power supply ON
- 37 Mixed output attenuation ON
- 38 Receiver channel
- 39 Digital code ON
- 40 Output level LINE/MIC
- 41 Antenna selection A/B
- 42 Volume
- 43 Transmitter battery
 - 3blocks: R-4TH / R-4THA/R-4TB
microphone is used
 -   
 - 5blocks: JSS-4A microphone is used
 -     
- 44 Group / channel
- 45 Frequency

4-2 UHF PLL handheld transmitter // **R-4TH / R-4THA**

- ① **Power ON/OFF** : push once to turn on. Push and hold for 2 seconds while the power is on to turn off. While the power is on, a quick push of this button will show the Device ID on the LCD display.
- ② **Mute** : switch up to talk and down to mute while the power is on. If the power is off, switching up from mute will turn the microphone on. In mute, it is allowed to select 1, 10 or 30 minutes to automatically turn the microphone off.
- ③ **Battery compartment** : it holds 2 UM3, AA 1.5V Alkaline batteries or MiNH rechargeable batteries.
- ④ **LED indicator** : it shows the microphone's status, including battery power, mute and pairing.
- ⑤ **LCD display** : it shows the parameter settings of transmitter.
- ⑥ **SET** : for parameter settings, including frequency, group, channel, sensitivity, transmission frequency, auto off time, Device ID , **REMOSET**® function (ON/OFF).
- ⑦ **Up/down selection keys** : they are used with "SET" to change parameter settings. Before entering the setting mode, a quick push will show the Device ID on the LCD display.
- ⑧ **LOCK**  : push and hold "LOCK" for 2 seconds to lock and again to unlock. Under "LOCK" status MUTE function is still valid.
- ⑨ **Charging contact module**: if rechargeable batteries are used, charging is possible with the matching charger.

Note : R-4TH is the same as R-4THA except that the battery cover of the R-4THA is made of metal.

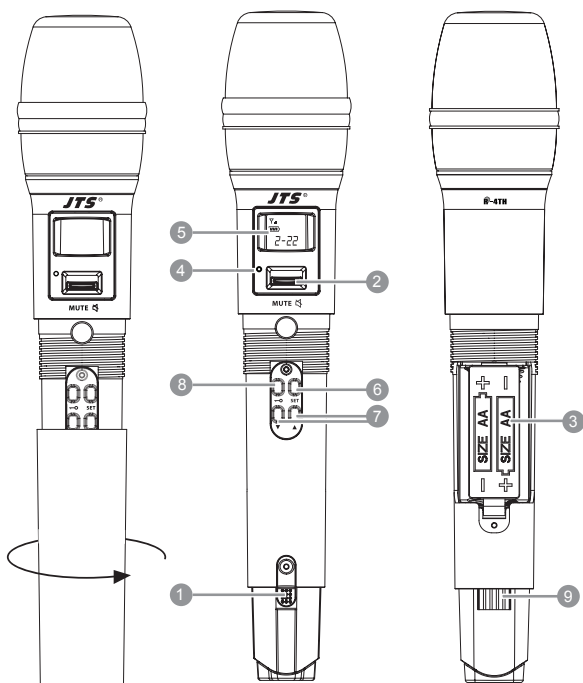

R-4TH / R-4THA LCD displays

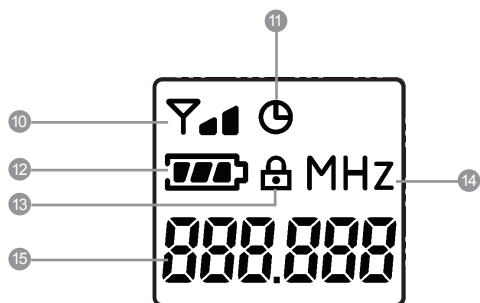

- ⑩ RF output power (1 block is 10mW and 2 blocks are 50mW)
- ⑪ Auto off ON
- ⑫ Battery level
- ⑬ Key lock
- ⑭ Frequency (MHz)
- ⑮ Indication of frequency, group and channel

4-3 UHF PLL handheld transmitter // **JSS-4A** / **JSS-4B**

① LCD display

② **SET** : for handheld transmitter setting and saving

③ **▲**、**▼** : up and down; used to select the desired item for handheld transmitter.

④ **Power ON/OFF**

(1) Turn the handheld transmitter on

Power on: push the button once to turn on

Power off: push and hold for 1 second until the LCD display shows "power off."

(2) Mute : while the handheld transmitter is in use (main page on the LCD display)

Mute : push the Power ON/OFF and the display shows "mute."

Unmute : push the Power ON/OFF again and the display shows "unmute."

(3) Exit setting menu

In the setting menu: push Power ON/OFF to return to main page.

In the function setting menu: push Power ON/OFF to return to the setting menu, and again to return to main page.

⑤ **Battery compartment**

⑥ **Charging contact**: used with the charger (optional for CH-2 or CH-8)

⑦ **Slide cover**

⑧ **Detachable capsule module**

⑨ **LED status indication**

Green: Power ON

Blue: Remoset done (on for about 5 seconds)

Red: battery low

Blinking red: mute

Blinking red/green: battery low and mute

JSS-4A

JSS-4B

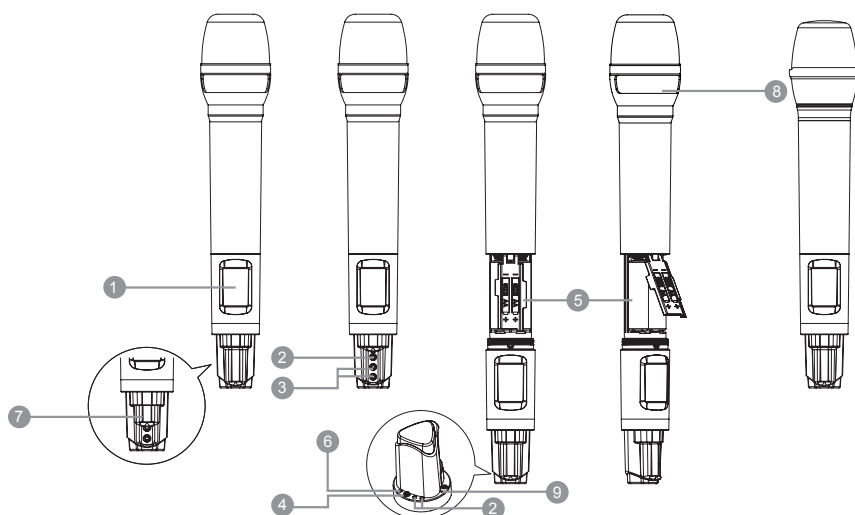

JSS-4A / JSS-4B LCD displays

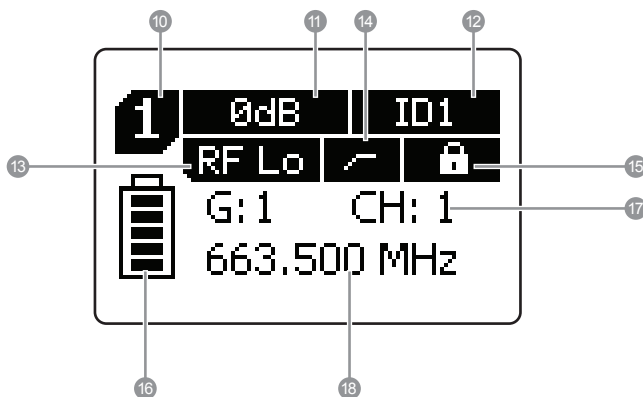

- 10 Channel number for the matching receiver
- 11 Microphone sensitivity
- 12 Device ID
- 13 RF output power
- 14 Low cut ON
- 15 Key lock
- 16 Transmitter battery
- 17 Group/channel
- 18 Frequency

4-4 UHF PLL body-pack transmitter // **R-4TB**

- 1 **Power/mute** : push once to turn the power on. While the power is on, one quick push to mute and again to unmute. Push and hold for 2 seconds to turn off.
- 2 **LED indicator** : it shows the transmitter's status, including battery power, mute and pairing.
- 3 **LCDdisplay** : it shows the parameter settings of transmitter.
- 4 **Antenna** : transmitter antenna
- 5 **Microphone input** : 4-pin mini XLR
- 6 **SET** : for parameter settings, including frequency, group, channel, sensitivity, transmission frequency, auto off time, Device ID , **REMOSET**® function (ON/OFF).
- 7 **Up/down selection keys** : they are used with "SET" to change parameter settings. Before entering the setting mode, a quick push will show the Device ID on the LCD display.
- 8 **Battery compartment** : it holds 2 UM3, AA 1.5V Alkaline batteries or MiNH rechargeable batteries.
- 9 **Charging contact** : if rechargeable batteries are used, charging is possible with the matching charger.

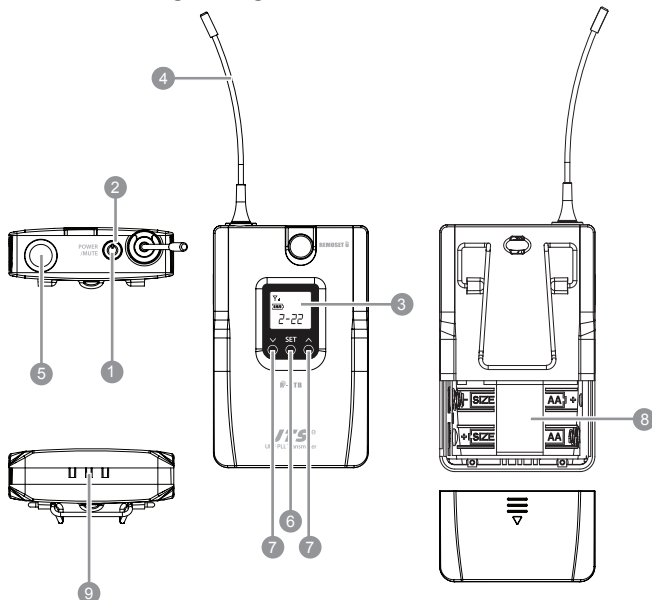

P-4TB LCD displays

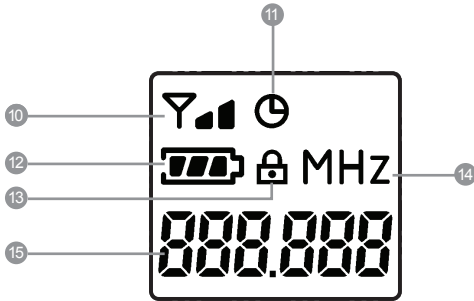

- 10 RF output power (1 block is 10mW and 2 blocks are 50mW)
- 11 Auto off ON
- 12 Transmitter battery
- 13 Key lock
- 14 Frequency (MHz)
- 15 Indication of frequency, group and channel

① **LCD display**

② **Battery level**

Red: battery low; replace battery

③ **REMOSET indicators**

Blue: Remoset transmitting (approximately 5 seconds)

④ **Power:**

(1) On: push the power button

Off: push and hold the power button for 2 seconds till the display shows "Power Off."

(2) Exit Setting Menu: when in the Setting Menu, push the power button to return to the main screen.

⑤ **▲ 、▼ : up and down buttons for selection**

⑥ **SET:** to set and save

⑦ **Mute Switch / LED Indicator :**

(1) Show green light when power is on.

(2) Show red light when battery level is too low.

(3) Flash red light when switch to "MUTE" function to mute the transmitter.

(4) Flash red light and green light when mute function is on and battery level is too low.

⑧ **Battery tray**

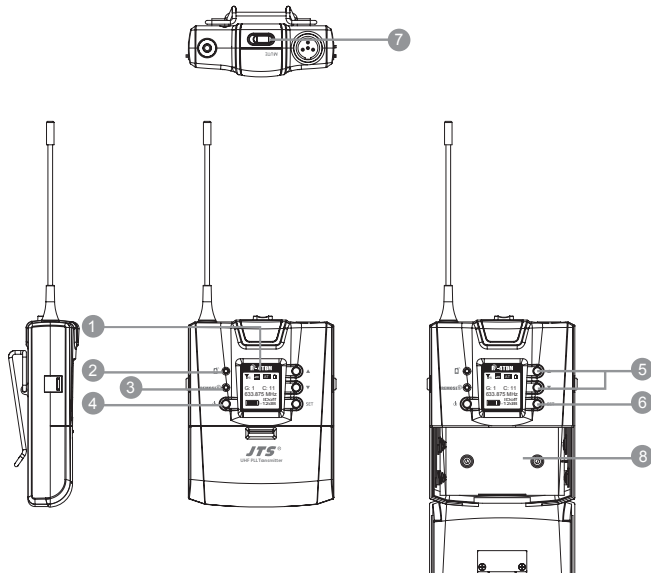

RP-4TBM LCD displays

- ⑨ Transmission Power: Hi (High) and Lo (Low)
- ⑩ Indicate current Group and current Channel
- ⑪ Frequency: it shows the RF frequency
- ⑫ Battery level: in 5 levels
- ⑬ Sensitivity Value
- ⑭ Low Cut indication
- ⑮ Attenuate Indication
- ⑯ Lock On Statue

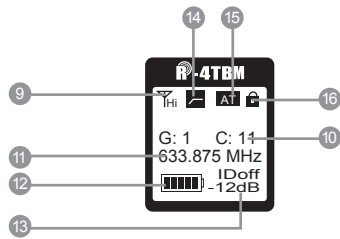

For screen display and operation please refer to "6-5. System operation setup for Body-Pack transmitter".

4-6 Accessories

- 1 AC power cable* 1
- 2 Cascading RF cable* 2
- 3 XLR(M)/XLR(F) Audio cable * 1
- 4 AC power cascading cable* 1
- 5 MH-56 Microphone Holder * 1

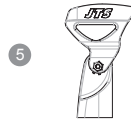
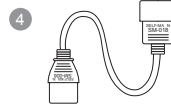
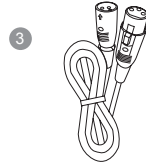

4-7 Microphone Choices

Lavaliere microphone // CM-501 CM-201i CM-125i

- 1 Clip
- 2 4-pin mini XLR
- 3 Wind shield

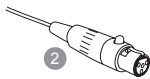

CM-501

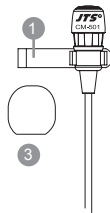

CM-201i

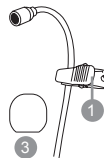

CM-125i

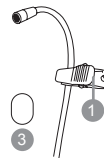

Note: CM-501 is standard accessory.

Headset microphone // CM-214i CM-214Ui CM-214ULi CM-235i CX-504

- 4 Gooseneck
- 5 Adjustable head ring
- 6 Head ring
- 7 4-pin mini XLR
- 8 Wind shield

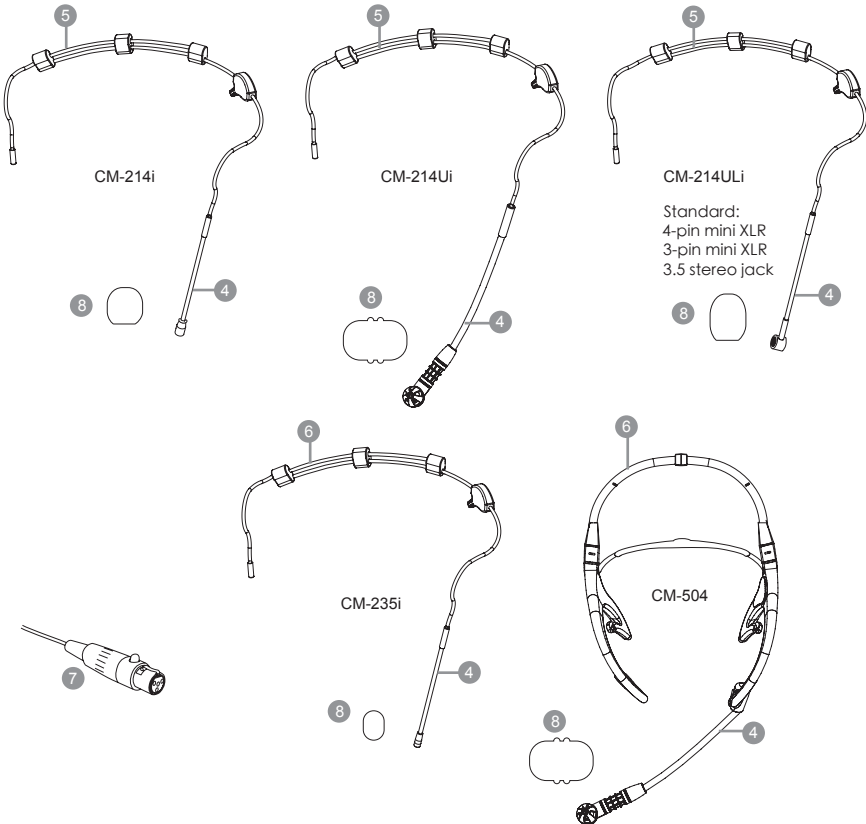

Ear-hook microphone // CM-801 CM-804i CM-8015 CM-825i

- 9 Boom
- 10 Adjustable Headband
- 11 Adjustable ear hook
- 12 Detachable cable
- 13 Clip
- 14 Windscreen
- 15 4-pin mini XLR
- 16 3-pin mini XLR optional optional
- 17 3.5 stereo jack optional optional
- 18 4-pin Hirose jack optional

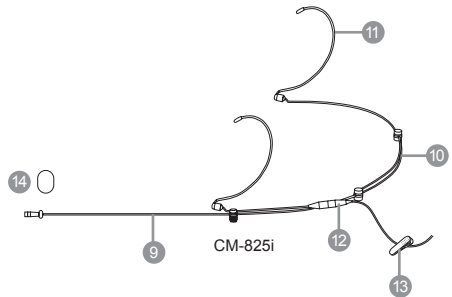
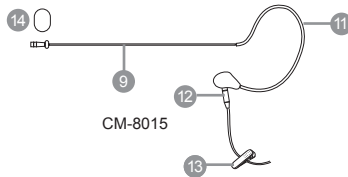
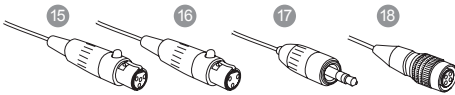
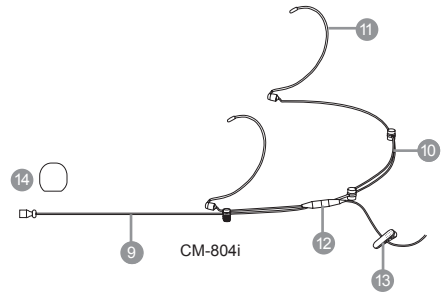
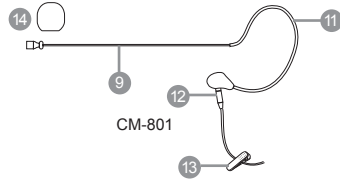

5. Connection

5-1 Connecting the receiver

1.Connect the audio signal cable

Connect the **PH-4** / **PH-2** audio output to a mixer or an amplifier:
Audio cable: one end of the XLR or $\phi 6.3\text{mm}$ audio cable is connected to the "AF output balanced" of **PH-4** / **PH-2** and the other to the audio input of the mixer or amplifier.

2.Connect the power

Connect AC power cable: insert one end to the receiver's AC jack and the other to AC power outlet (100~240VAC).

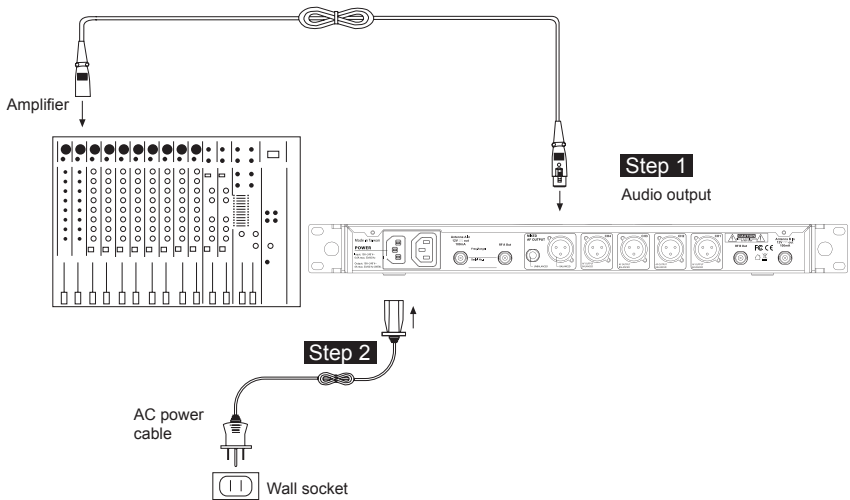

Cascading of AC power cable and antennas (for R-4 only)

*Up to 10 units can be cascaded for power/antenna.

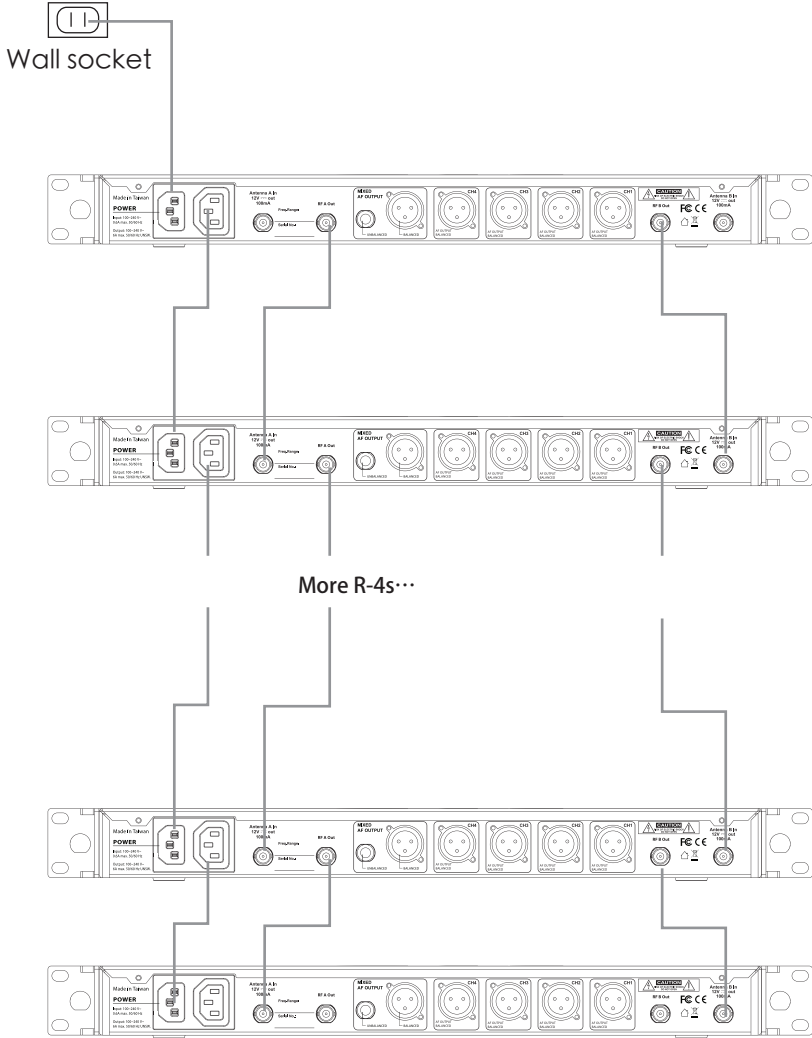

5-2 Installing transmitter // R-4TH / R-4THA

The mute switch of handheld transmitter also serves to turn the power on. Therefore, the power will come on when the batteries are replaced. Place the mute switch at mute if you do not want to turn the power on immediately after battery replaced.

1. Unscrew the outer tube of the transmitter. (Figure 1)
2. Place 2 AA batteries in the battery compartment according to their polarity. (Figure 2)
3. Screw the outer tube back on. (Figure 3)
4. To turn the transmitter on:
 - a. Push Power ON/OFF to turn on. (Figure 4a)
 - b. Or, turn the power on by switching the MUTE switch up. (Figure 4b)
5. Define the transmitter parameters according to the instructions.

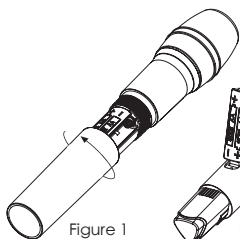

Figure 1

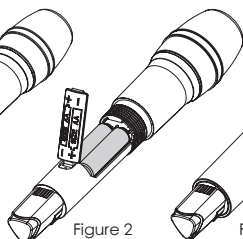

Figure 2

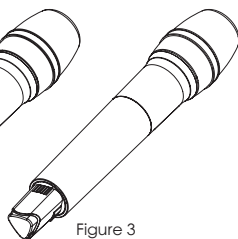

Figure 3

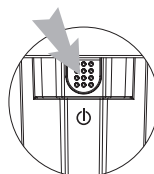

Figure 4a

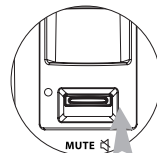
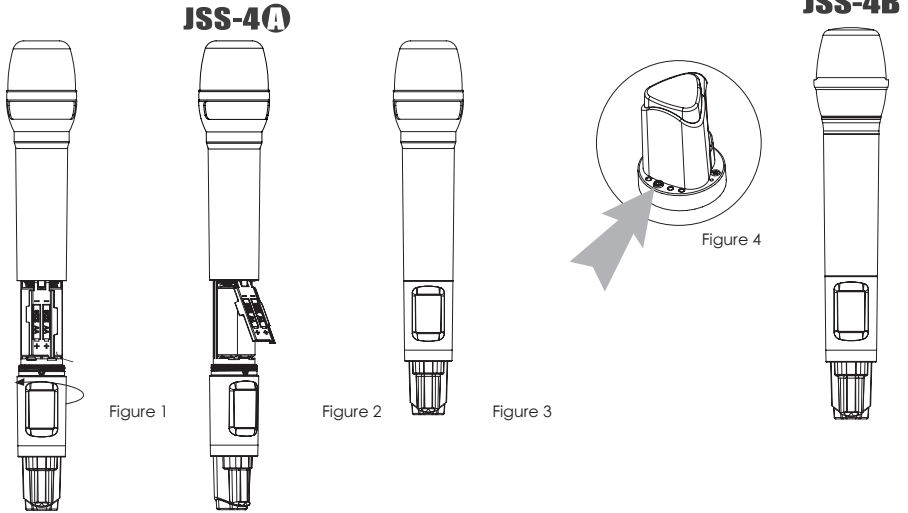

Figure 4b

5-3 Installing transmitter // **JSS-4A** / **JSS-4B**

1. Unscrew the outer tube of the transmitter.(Figure 1)
2. Place 2 AA batteries in the battery compartment according to their polarities.(Figure 2)
3. Screw the outer tube back on.(Figure 3)
4. Turn the transmitter on.(Figure 4)
5. Define the transmitter parameters according to the instructions.



5-4 Installing transmitter // **R-4TB**

1. Slide the battery cover open as indicated by the arrow. (Figure 1)
2. Place 2 AA batteries in the battery compartment according to their polarity.(Figure2)
3. Slide the battery cover back on.(Figure3)
4. Depending on the type of microphone, insert the 4-pin mini XLR into MIC IN to finish the installation.(Figure4)
5. Push Power ON/OFF to turn on. (Figure5)
6. Define the transmitter parameters according to the instructions.

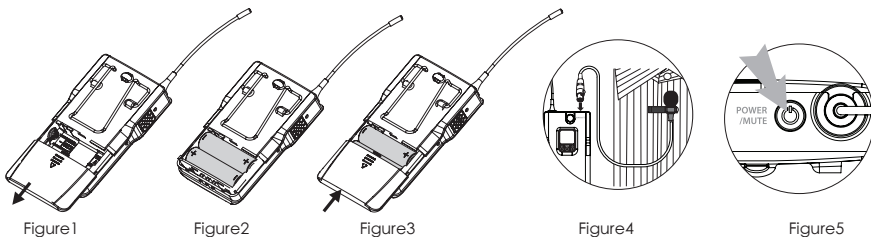

5-5 Installing transmitter // **R-4TBM**

1. Open the battery cover as indicated by the arrow. (Figure 1)
2. Place 2 AA batteries in the battery compartment according to their polarity. (Figure2)
3. Close the battery cover back on. (Figure3)
4. Depending on the type of microphone, insert the 4-pin mini XLR into MIC IN to finish the installation. (Figure4)
5. Push Power ON/OFF to turn on. (Figure5)
6. Define the transmitter parameters according to the instructions.

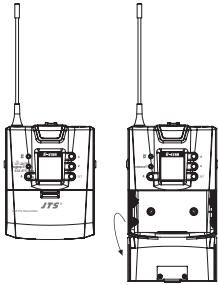

Figure1

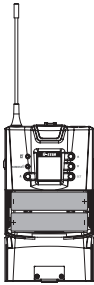

Figure2

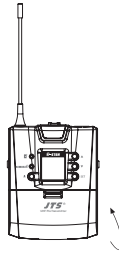

Figure3

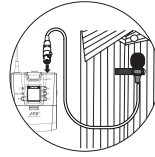

Figure4

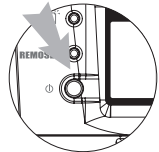

Figure5

6. Operation

6-1 Operation // **R-4** / **R-2**

Parameter settings _____

Push and hold "SET" for 2 seconds to enter the setting mode. Turn the rotary switch to select the desired item. Push the rotary switch (or SETUP) to enter the setting page. Spin the switch to select the desired value or function. Push SETUP to save the settings. Push EXIT to return to the previous page.

System Settings

○Display

Contrast	0~9 (default: 5)
Brightness	0~9 (default: 5)

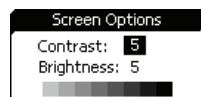

○Antenna power supply

ON	(DC12V/100mA is provided to) power the external antenna booster.
OFF	

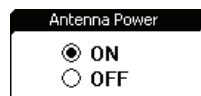

○Mixed output level

OFF(Line)	Line output is selected for balanced mixing output level.
ON(Mic)	Mic output is selected for balanced mixing output level.

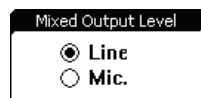

○Reset to factory defaults

Push and hold SETUP for 2 seconds and the system is reset to factory defaults and restarts.

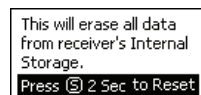

○Return

Return: push SETUP to return to the previous page.

Self-defined groups

○Edit a self-defined group

G	U1~U6 (group no.)
CH	1~24 (channel)
---.---MHz (frequency setting)	

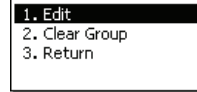

○Delete a self-defined group

Group	Select the group to be deleted from U1~U6, push SETUP and the program will ask if you want to delete the group. Push "Yes" to delete.
-------	---

○Return

Return: push SETUP to return to the previous page.

Define receiver channel

1. Push and hold SETUP for 2 seconds. Spin the rotary switch to select the desired receiver channel in the main menu. Push the switch to start defining.

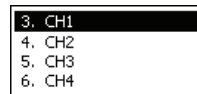

or

2. Push SEL of the receiver channel to be defined. Push and hold SETUP for 2 seconds to start defining.



Receiver channel 1

◎Frequency setting

Select the left 3 digits of the frequency; spin the rotary switch to adjust in the increment of "+/-" 1 MHz. Push the switch to confirm the selection. Select the right 3 digits of the frequency; spin the rotary switch to adjust in the increment of "+/-" 0.025 MHz. Push SETUP to confirm and save the selection.



◎Default group

Spin the rotary switch to select group "G:" through 1 to 6: Push the switch to confirm the selection. Spin the rotary switch again to select channel "CH:" up to 22 channels are available. Push SETUP to confirm and save the selection.



◎Channel scan

Scan all groups	Push the rotary switch to start scanning. The system goes to the selection page once the scanning is done. It is also possible to arrive at here through menu.
Scan result	Push the rotary switch to enter the selection page and examine the result. Select an available channel and push SETUP to save the selection.
Scan current group	The next group will be scanned every time the rotary switch is pushed. Make the selection and push SETUP to save it.

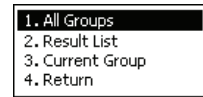

◎ Squelch

+15~-5 : the higher the value, the less sensitive the receiving, and vice versa. The default is 0.

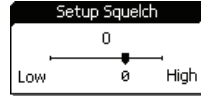

◎ Device ID

Device ID: 0~255: this setting affects the use of REMOSET; both the receiver and transmitter must be on the same Device ID before REMOSET is available.

Note: this does not apply when the microphone Device ID is not activated.

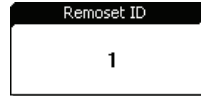

◎ Output Level

Line	Line output is selected for channel 1 balanced output level.
Mic	Mic output is selected for channel 1 balanced output level.

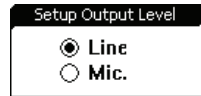

◎Microphone options

Sensitivity

Adjustment range : -15dB~+15dB ; the default is 0.



Input attenuation

ON	Audio input attenuation by 20dB (depending on whether the transmitter has the corresponding function)
OFF	No attenuation (default)

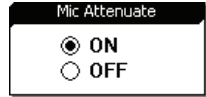

RF power

HI	High transmission power 50mW
LO	Low transmission power 10mW (default)

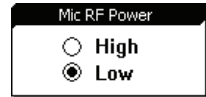

Key lock

Lock ON	Microphone is in the Lock ON mode as pairing is complete
Lock OFF	Microphone is not locked as pairing is complete



Synchronization options

Use the rotary switch to search the items for REMOSET and push the knob to select.

- Frequency
- Sensitivity
- Attenuate
- RF Power
- RF Power
- KeyLock
- Save and exit
- Exit without saving

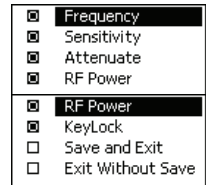

Push SETUP to save the selection, or just select "Save and Exit."

*At least one of the above has to be selected.

Return

Return: push SETUP to return to the previous page.

⊙DigCode(digital anti-interference)

ON	Digital code activated
OFF	Digital code deactivated



⊙Return

Return: push SETUP to return to the previous page.

Receiver channel 2

⊙See channel 1

Receiver channel 3

⊙See channel 1

Receiver channel 4

⊙See channel 1

Exit setting

Push SETUP to exit the setting page and return to the main page.

Volume adjustment _____

Push▲/▼key at each channel to adjust the volume up or down.
Mute, -31dB ~ 0dB. The default is -10 dB.

Pairing for REMOSET

1. REMOSET : push REMOSET and the blue indicator will start flashing, indicating that the frequency data is being transmitted.
2. REMOSET successful : the blue indicator lights up on the transmitter for 3 seconds and that on the receiver stops flashing.
3. REMOSET failed : if the blue indicator flashes slowly on the receiver, check that :
 - (1) The "frequency range labels" on "both" the receiver and transmitter are the same;
 - (2) "Pairing" in the function menu of the transmitter is "activated;"
 - (3) The "Device ID" on the transmitter is the same as that on the receiver; and
 - (4) Transmitter battery is low (synchronization is impossible when battery is low).

*It should be avoided to have two or more receivers on REMOSET when REMOSET is used, as sometimes it prevents pairing due to the mutual interference of REMOSET signals.

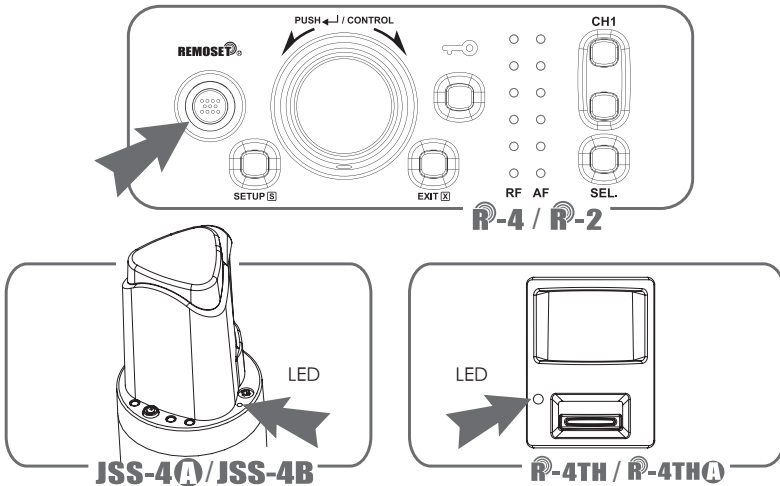

4. Pairing 4 microphones simultaneously: push REMOSET and the blue indicator starts to flashing. On the display all 4 receiver channels show "Synchronizing," indicating that data are being transmitted to all 4 microphones.

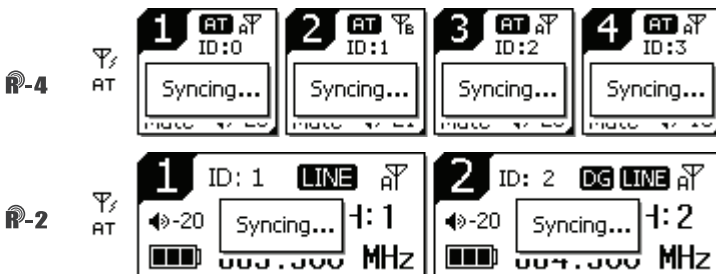

5. Pairing a single microphone: push SEL of the receiver channel to be paired.
 Push REMOSET and the blue indicator starts to flash. On the display the receiver channel is "Synchronizing," indicating that data is being transmitted to that microphone.

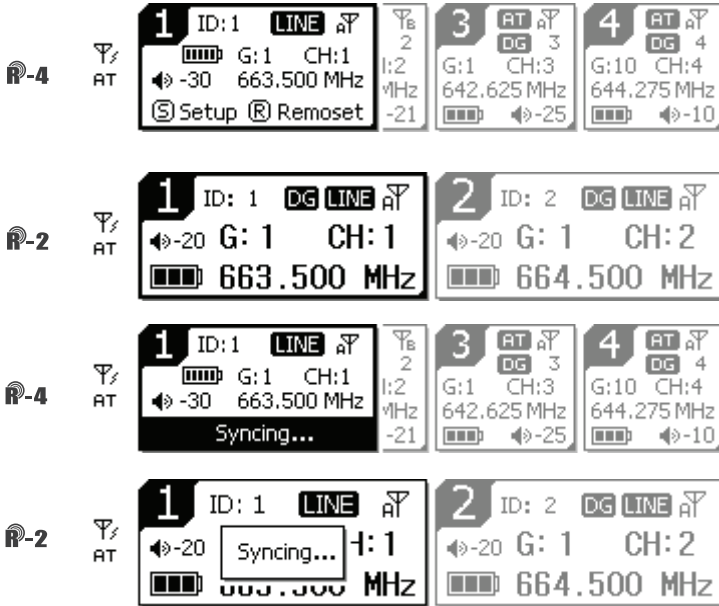

Others

Push "SEL" below each of the channel volume keys:
 Push SETUP to enter the page containing the selections of that channel for parameter settings.
 Push REMOSET to start pairing that channel; other channels remains standing by.

6-2 Operation // /

Push and hold SET for 2 seconds to enter the setting mode. Push SET repeatedly to locate the desired item. Use ▲/▼ for parameter settings. Push SET again to save the changes and exit.

◎ FREQ: frequency setting

Increment of 1MHz	Select with ▲/▼
Increment of 0.025MHz	Select with ▲/▼

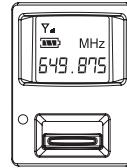

Start with those digits in 1MHz and then those in 0.025MHz

◎ GROUP: group/channel setting

G (group)	Select default group 1~6
CH (channel)	Select default channel(s), up to 22

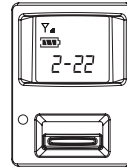

Start with group number and then channel number.

Sensitivity: for microphone input

Normal sensitivity	GAIN : +15dB
	GAIN : +12dB
	GAIN : +9dB
	GAIN : +6dB
	GAIN : +3dB
	GAIN : 0dB(default)
	GAIN : -3dB
	GAIN : -6dB
	GAIN : -9dB
	GAIN : -12dB
GAIN : -15dB	

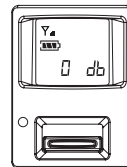

The sensitivity is at GAIN 0dB (default) as shown above.

◎ RFP: RF power of microphone

rF Lo	10mW (default)
rF Hi	50mW

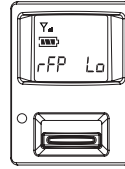

RFP low

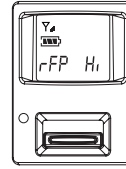

RFP Hi

◎AUTO-OFF: time to turn off microphone automatically (in MUTE)

OFF	Deactivated
1	1 minute to auto off
10	10 minutes to auto off
30	30 minutes to auto off

Note: default is 10 minutes.

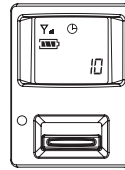

◎ Device ID

ID OFF	Device ID deactivated
ID 0~255	Device ID 0 ~ 255

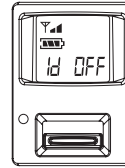
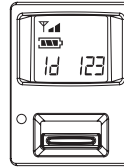

◎ Remoset (ON/OFF)

Syn on	Remoset activated
Syn off	Remoset deactivated

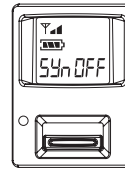
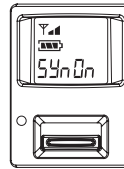

◎Digital code (digital anti-interference)

ON	Digital code activated
OFF	Digital code deactivated (The receiver will be in mute status if receiver has this function activated.)

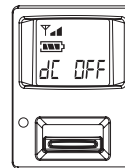
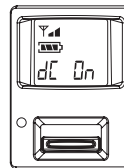

Indicator

Green: power is sufficient, $> 2V$

Green flashing: microphone mute

Red: power low, $\leq 2V$

Red and green flashing alternately: microphone mute
and power low

Blue: on for 3 seconds, indicates pairing successfully

Blue flashing: data receiving error

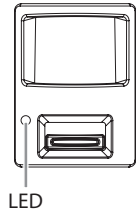

Others

Battery charging is supported. The transmitter turns off automatically when charging.

When battery is $< 1.8V$, the transmitter will turn off automatically.

If the microphone is turned off with the mute switch on mute, just slide the switch up to turn the microphone on.

6-3 Operation // **JSS-4A** / **JSS-4B**

6-3-1 Power ON/OFF

(1) Power on

To turn on: push Power ON/OFF once.

To turn off: push and hold Power ON/OFF until the display shows "power off."

Note: when the button is pushed and held, "mute on" or "mute off" will come out first before "power off."

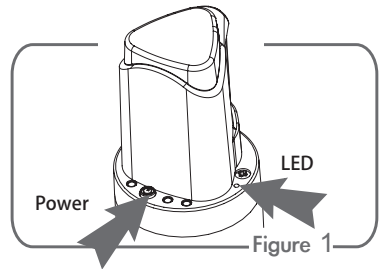

(2) Mute: when the transmitter is in use (the display is at the main page)

To mute: Short push Power ON/OFF and the display shows "mute on."

When in mute, the power indicator is flashing red and the display shows mute on.

To unmute: Short push Power ON/OFF and the display shows "mute off."

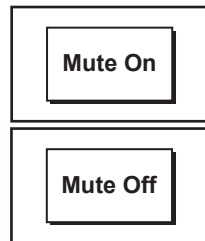

(3) Exit the setting menu

When in setting menu: push Power ON/OFF to return to the main page.

When in function "items": push Power ON/OFF once to return to the setting menu and again to the main page.

**The display will show "battery low" when the battery is low. In about 30 minutes, the transmitter will turn itself off automatically.

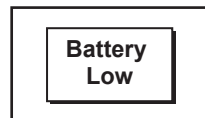

6-3-2 Menu function settings

Push and hold SET for 2 seconds to enter the function setting menu.

(1) Push ▲ or ▼ to selected the desired item.

Push SET to show the default setting.

(2) When the default is shown, use ▲ or ▼ to change the setting and then push SET to save the change.

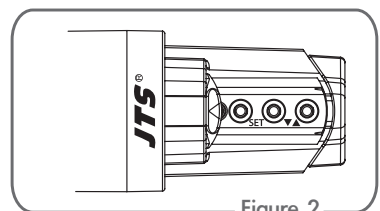

Figure 2

1. Frequency

(1) Use ▲ or ▼ to move to "1. Frequency setting." Push SET to enter the setting page.

1. Frequency
2. Group / Channel
3. Sensitivity

(2) To adjust the first 3 digits of the frequency, use ▲ or ▼ to adjust in the increment of "+/- " 1 MHz. Push SET to adjust the 3 digits on the right.

Frequency
624.000 MHz
G: 1 CH: 1

(3) To adjust the 3 digits on the right: use ▲ or ▼ to adjust in the increment of "+/-" 0.025 MHz. Push SET to save the change and exit.

Frequency
624.000 MHz
G: 1 CH: 1

2. Group / Channel

(1) Use ▲ or ▼ to move to "2. Group / Channel." Push SET to enter the setting page.

1. Frequency
2. Group / Channel
3. Sensitivity

(2) Select the desired group with ▲ or ▼. Push SET to save and to the channel settings.

Group / Channel
G: 1 C: 1
625.500 MHz

(3) Select the desired channel with ▲ or ▼. Push SET to save the change.

Group / Channel
G: 1 C: 1
625.500 MHz

3.Sensitivity

(1) Use ▲ or ▼ to move to "3. Sensitivity."
Push SET to enter the setting page.

1 Frequency
2. Group / Channel
3. Sensitivity

(2) Adjust the sensitivity with ▲ or ▼ in the increment of 3 dB. Save the change by pushing SET. The sensitivity ranges from -15dB to +15dB.

Sensitivity
0 dB

4.Low Cut

Use ▲ or ▼ to move to "4. Low Cut"
Push SET to enter the setting page.

2. Group / Channel
3. Sensitivity
4. Low Cut

Push ▲ to deactivate Low Cut function.

Low Cut
Off 

Push ▼ to activate Low Cut function.

Low Cut
On 

Push SET to save the change.

5. Device ID

(1) Use ▲ or ▼ to move to "5. Device ID." Push SET to enter the setting page.

Setting page

(2) Use ▲ or ▼ to select the Device ID between 0 and 255. Push SET to confirm the selection and go to Device ID on/off.

Push ▲ to activate. The microphone has to be on the same Device ID with the receiver in order for REMOSET to work.

Push ▼ to deactivate. The microphone will receive the REMOSET data from any receiver with REMOSET function regardless its Device ID.

Push SET to save the change.

5. Device ID
6. Remoset
7. RF Power

Device ID
0
ID: On

Device ID
0
ID: Off

6. Remoset

Use ▲ or ▼ to move to "6. Remoset." Push SET to enter the setting page.

Push ▲ to activate. Remoset is activated.

Push ▼ to deactivate. Remoset is deactivated, but the microphone is more energy efficient this way. When pairing is not needed, it is recommended to deactivate it to extend the battery power.

Push SET to save the change.

5. Device ID
6. Remoset
7. RF Power

Remoset
<input checked="" type="radio"/> On
<input type="radio"/> Off

7. RF Power :

Use ▲ or ▼ to move to "7. RF Power."
Push SET to enter the setting page.

Push ▲: high → high RF power
Push ▼: low → low RF power

Push SET to save the change.

Note: The microphone drains more power out of battery with high RF power.

5. Device ID
6. Remoset
7. RF Power
RF Power
<input checked="" type="radio"/> High
<input type="radio"/> Low

8. Contrast :

(1) Use ▲ or ▼ to move to "8. Contrast." Push SET to enter the setting page.

(2) Adjust the contrast using ▲ or ▼. The larger the value, the dark it is, and vice versa. The contrast ranges from 0 to 20.

8. Contrast
9. Light time
a. DigiCode
LCD contrast
10

9. Light time

(1) Use ▲ or ▼ to move to "9. Light time." Push SET to enter the setting page.

(2) Adjust the time using ▲ or ▼.
Available for selection: off, 5~30 sec
(increment of 5 seconds), always on.

8. Contrast
9. Light time
a. DigiCode
Light time
10 sec

10. DigiCode

Use ▲ or ▼ to move to "a. DigiCode."

Push SET to enter the setting page.

Push ▲ to activate. The microphone will transmit digital code signals.

Push ▼ to deactivate. The microphone will not transmit digital code signals. The receiver will be in mute status if receiver has this function activated.

a. DigiCode
b. Reset
c. KeyLock

11. Reset

Use ▲ or ▼ to move to "b. Reset." Push SET to enter the setting page.

Push ▲ to confirm and the handheld transmitter will be reset.

Push ▼ to cancel the reset.

Push SET to save the change.

a. DigiCode
b. Reset
c. KeyLock

This will erase all data from Mic Internal Storage.
Yes / No

12. KeyLock

Use ▲ or ▼ to move to "c. KeyLock."

Push SET to enter the setting page.

(1) Push ▲: all keys will be locked to prevent accidental triggering of any button.

Push SET to save the change.

Push ▼ to "unlock" and the key lock is deactivated.

Push SET to save the change.

a. DigiCode
b. Reset
c. KeyLock

KeyLock
<input checked="" type="radio"/> ON
<input type="radio"/> OFF

(2) Unlock: when the display is in the main page, push and hold SET for 2 seconds to go to the key lock page. Push ▼ to unlock.

Push SET to save the change.

b. Reset
c. KeyLock
d. Exit

13. Exit

Use ▲ or ▼ to move to "d. Exit." Push SET to return to the main page.

6-4 Operation // **IP-4TB**

Parameter settings _____

Push and hold SET for 2 seconds to enter the setting mode. Push SET repeatedly to select the desired item. Use ▲ / ▼ for parameter settings. Push SET again to save the change and exit.

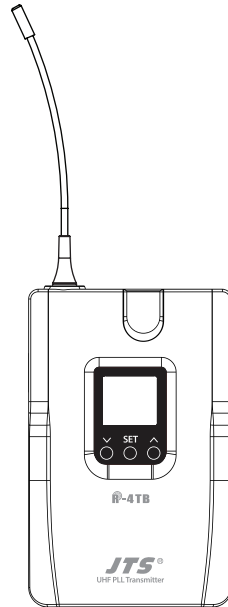

◎ **FREQ:** Frequency setting

Increment of 1MHz	Select with▲/▼
Increment of 0.025MHz	Select with▲/▼

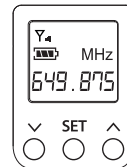

Start with those digits in 1MHz and then those in 0.025MHz

◎ **GROUP:** group/channel setting

G (group)	Select default group 1~6
CH (channel)	Select default channel(s), up to 22

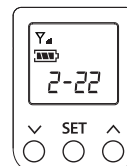

Start with group number and then channel number.

Sensitivity: microphone input sensitivity

Normal sensitivity	GAIN : +15dB
	GAIN : +12dB
	GAIN : +9dB
	GAIN : +6dB
	GAIN : +3dB
	GAIN : 0dB
	GAIN : -3dB
	GAIN : -6dB
	GAIN : -9dB
	GAIN : -12dB
GAIN : -15dB	

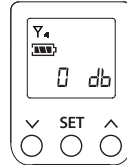

The sensitivity is at GAIN 0dB (default) as shown above.

ATT: Microphone input attenuation

At off	No attenuation for audio input
At on	20dB attenuation for audio input

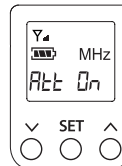

The audio input attenuation is 20dB as shown above.

RFP: RF power of the transmitter

Two output levels can be chosen (as per local regulation)

rF Lo	10mW(default)
rF Hi	50mW

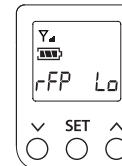

RFP low

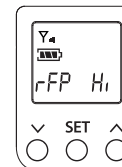

RFP HI

AUTO-OFF: time to turn off microphone automatically (in Mute status)

OFF	Deactivated
1	1 minute to auto off
10	10 minutes to auto off
30	30 minutes to auto off

Note: default is 10 minutes.

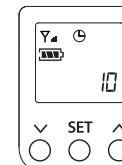

◎ Device ID

ID OFF	Device ID deactivated
ID 0~255	Device ID 0 ~ 255

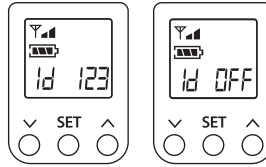

◎ Remoset (ON/OFF)

Syn on	Remoset activated
Syn off	Remoset deactivated

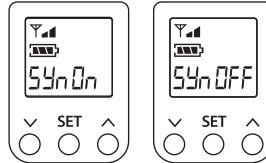

◎ DigiCode (digital anti-interference)

ON	Digital code activated
OFF	Digital code deactivated (The receiver will be in mute status if receiver has this function activated.)

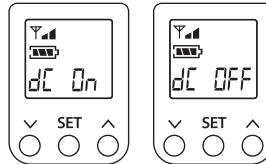

◎ Key lock

Loc on	Lock ON
Loc off	Lock OFF

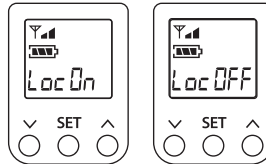

Indicator

Green: power is sufficient, > 2V

Green flashing: microphone mute

Red: power low, ≤ 2V

Red and green flashing alternately: microphone mute and power low

Blue: on for 3 seconds, indicates pairing successfully

Blue flashing: data receiving error

Others

Battery charging is supported. The transmitter turns off automatically when charging.

When battery is < 1.8V, the transmitter will turn off automatically.

6-5 Body-pack transmitter system operation setting // **R-4TBM**

6-5-1 To turn on R-4TBM body-pack transmitter (Fig.1)

- (1) To turn on the power: press the Power button.
- (2) To turn off the power: press the Power button for a while. The screen will display “Power OFF” after approx. 2 seconds. The body-pack transmitter will be turned off.
- (3) To exit the function setting menu: when you are at the function setting menu, press Power button to go back to the main screen.

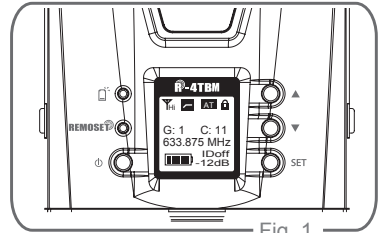

Fig. 1

6-5-2 Function setting menu:

Press SET for a while. After two seconds, it will go into the function setting menu.

- (1) Press ▲、▼ and select the desired item. Press SET to enter into the menu.
- (2) After entering into the menu, press ▲、▼ to adjust the values. Press SET to save the setting.

1. Frequency: set the frequency

- (1) Press ▲、▼ to frequency setting. Press SET to enter into the frequency setting screen.
- (2) When entering into the frequency adjustment screen, adjust the first three digits of frequency at the left. Press ▲、▼ using “+/-” with 1MHz as the unit of modification. After adjustment, press SET to adjust the three frequency at the right.
- (3) Adjust the three digits of frequency at the right: Press ▲、▼ using “+/-” with 0.025MHz as the unit of modification. After the adjustment, press SET to save the setting.

Frequency
Group/Chan
Sensitivity
Attenuate
Low Cut

Frequency
624.750
G: 1 C: 1
Frequency
624.750
G: 1 C: 1

2. Group / Channel

(1) Press ▲、▼ to select “2. Group / Channel.” Press SET to enter into the setting screen.

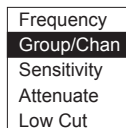

(2) After entering into the screen, press ▲、▼ to select desire Group. Press SET for saving and change into the channel setting.

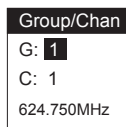

(3) Press ▲、▼ to select desire channel. Press SET to save the setting.

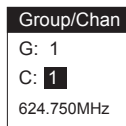

3. Sensitivity

(1) Press ▲、▼ to “Sensitivity.” Press SET to enter into the “Sensitivity” setting screen.

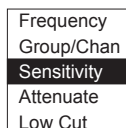

(2) Press ▲、▼ to adjust the sensitivity. Use 1 dB as unit of modification. After adjustment, press SET to save the setting; the range of sensitivity is -15dB~+15dB.

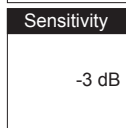
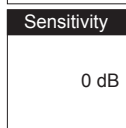

4. Attenuate

(1) Press ▲、▼ to enter into “Attenuate.” Press SET to enter into the “Attenuate” setting screen.

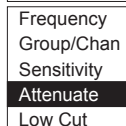

(2) Press ▲ to turn on

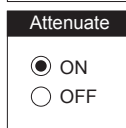

(3) Press ▼ to turn off

After adjustment, press SET to save the setting.

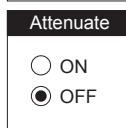

5. Low Cut

(1) Press ▲、▼ to select “Low Cut.” Press SET to enter into the “Low Cut” setting screen.

(2) Press ▲ to turn on the Low Cut function.

(3) Press ▼ to turn off the Low Cut function.

6. Device ID: to set the Device ID

(1) Press ▲、▼ to set the ID. Press SET to enter into “Device ID” setting screen.

(2) Press ▲、▼ to adjust the pre-set ID value. The range is from 0 ~ 255. After the adjustment, press SET to go to ID setting: On / Off

ID: On → The ID of the microphone and the ID of the receiver shall be the same as to use the REMOSET function.

ID: OFF → Ignore the ID value. The microphone will receive all REMOSET information transmitted by “receivers with ID code”

Press SET for setting.

This setting will affect the usage of REMOSET.

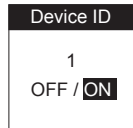
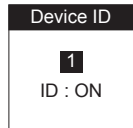
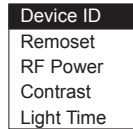
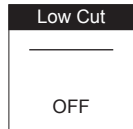
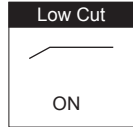
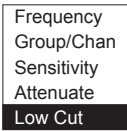

7. Remoset: to turn on/off the REMOSET

(1) Press ▲、▼ to select REMOSET function. Press SET to enter into “Remoset” setting screen.

(2) Press ▲: to turn on and REMOSET function can be used.

(3) Press ▼: to turn off. REMOSET function cannot be used. The microphone will be more power-saving. When not using REMOSET function, it can prolong the usage time of the battery when it is “OFF.”

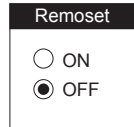
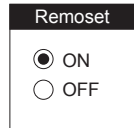
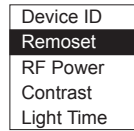

8. RF Power: setting of RF power

(1) Press ▲、▼ to select RF power. Press SET to enter into “RF Power” screen for RF power setting.

(2) Press ▲: High → High RF power

(3) Press ▼: Low → Low RF power.

Press SET to save the setting.

Note: When It is in “High RF power” , the power consumption of the microphone is larger which would shorten the usage time of the battery.

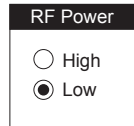
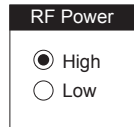
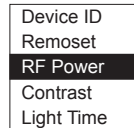

9. Contrast: adjustment of screen contrast

(1) Press ▲、▼ to select “Contrast.” Press SET to enter “Contrast” screen for contrast adjustment.

(2) Press ▲、▼ to adjust the contrast. The higher the value, the darker the color; on the contrary, it would be lighter. There is a total of 0~20, 21 level of adjustment.

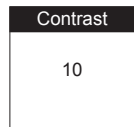
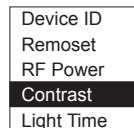

10. Light Time: the the backlight time

(1) Press ▲、▼ to select backlight time. Press SET to enter into “Light Time” screen.

(2) Press ▲、▼ to select the backlight time; you can select “closed” , “5~30 seconds” (having 5 seconds as the unit of change) or “constant light.”

The longer the backlight time, the shorter the usage time of the battery.

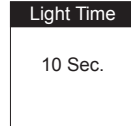
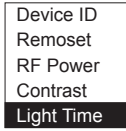

11. DigiCode

Use ▲ or ▼ to move to "DigiCode."

Push SET to enter the setting page.

Push ▲ to activate. The microphone will transmit digital code signals.

Push ▼ to deactivate. The microphone will not transmit digital code signals. The receiver will be in mute status if receiver has this function activated.

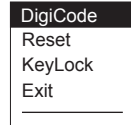

12. Reset

(1) Press ▲、▼ to select reset. Press SET to enter into “Reset” screen.

(2) Press ▲ to select confirm as to reset the internal information of the handheld transmitter. Press SET to save the setting.

(3) Press ▼ to select cancel as to cancel the reset setting. Press SET to save the setting.

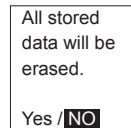
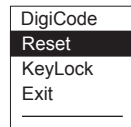

13. Key Lock: setting of the keypad lock

(1) Press ▲、▼ to the keypad lock. Press SET to enter into “key Lock” screen for keypad lock setting.

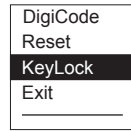

(2) Press ▲、▼ to select lock “ALL” , “Set & Power” only or lock “OFF” . Press SET to save the setting.

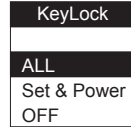

ALL: All the buttons are locked as to prevent any misoperation touch.(include Mute switch)

Set & Power: Only funtion buttons are locked, Mute switch will not be locked.

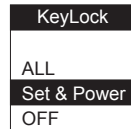

(3) Press ▲、▼ to select lock off. Press SET to save the setting.

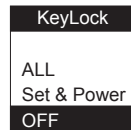

(4) To unlock: press SET for two seconds and it will directly go into the key lock screen. Press ▼to select OFF. Press SET to save the setting.

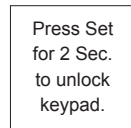

14. Exit

Press ▲、▼ to select exit setting. Press SET to go back to the main screen.

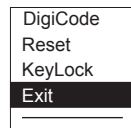

7. Digital Code Alert Function

When receiver's DigiCode function is ON, the alert screen will blink slowly under these circumstance:

1. When microphone is under mute mode or microphone's DigiCode function is OFF.



2. When microphone's power is OFF.



3. When microphone's battery level is too low.



When receiver's DigiCode function is OFF, the alert screen will blink rapidly under these circumstance:

1. When microphone is under mute mode.



2. When microphone's power is OFF.



3. When microphone's battery level is too low.



8. Notes for the product

- (1) For the optimized reception, keep the receiver 3m or more away from the transmitter.
- (2) Receivers and transmitters shall be kept at least 50cm away from any metal object.
- (3) Do not point the receiver directly into a speaker or there will be annoying feedback noises.
- (4) It is recommended to hold the transmitter (microphone) at the middle section for the optimized audio pickup.
- (5) In case that the microphone is not used for an extended period of time, it is recommended to remove the batteries from the battery bay in order to prevent electrolyte leaks from damaging the transmitter.
- (6) When changing the batteries, it is recommended to change both batteries of the same manufacturer for the optimized power performance.